

600 GPD DRIP SYSTEM H-600 AND

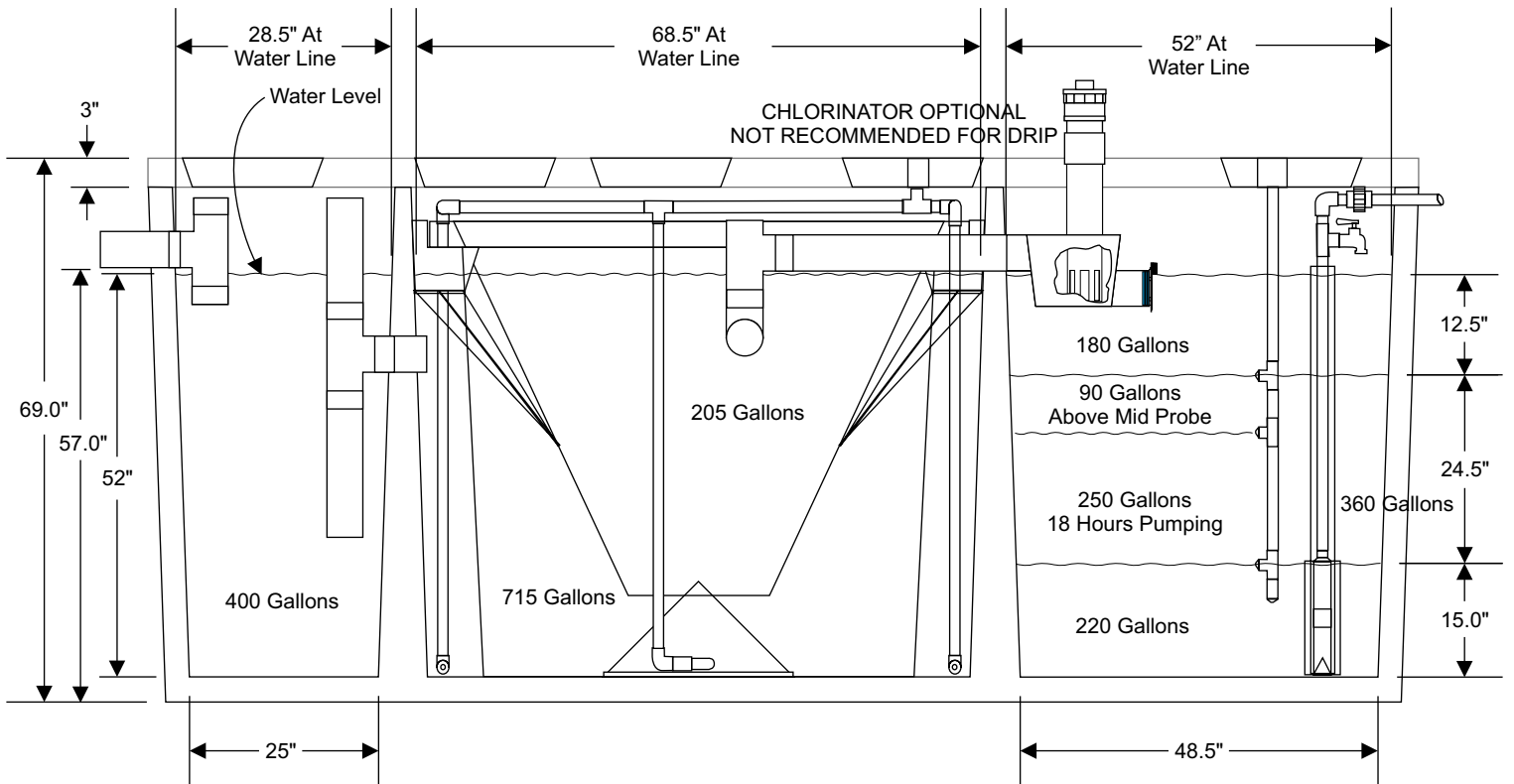
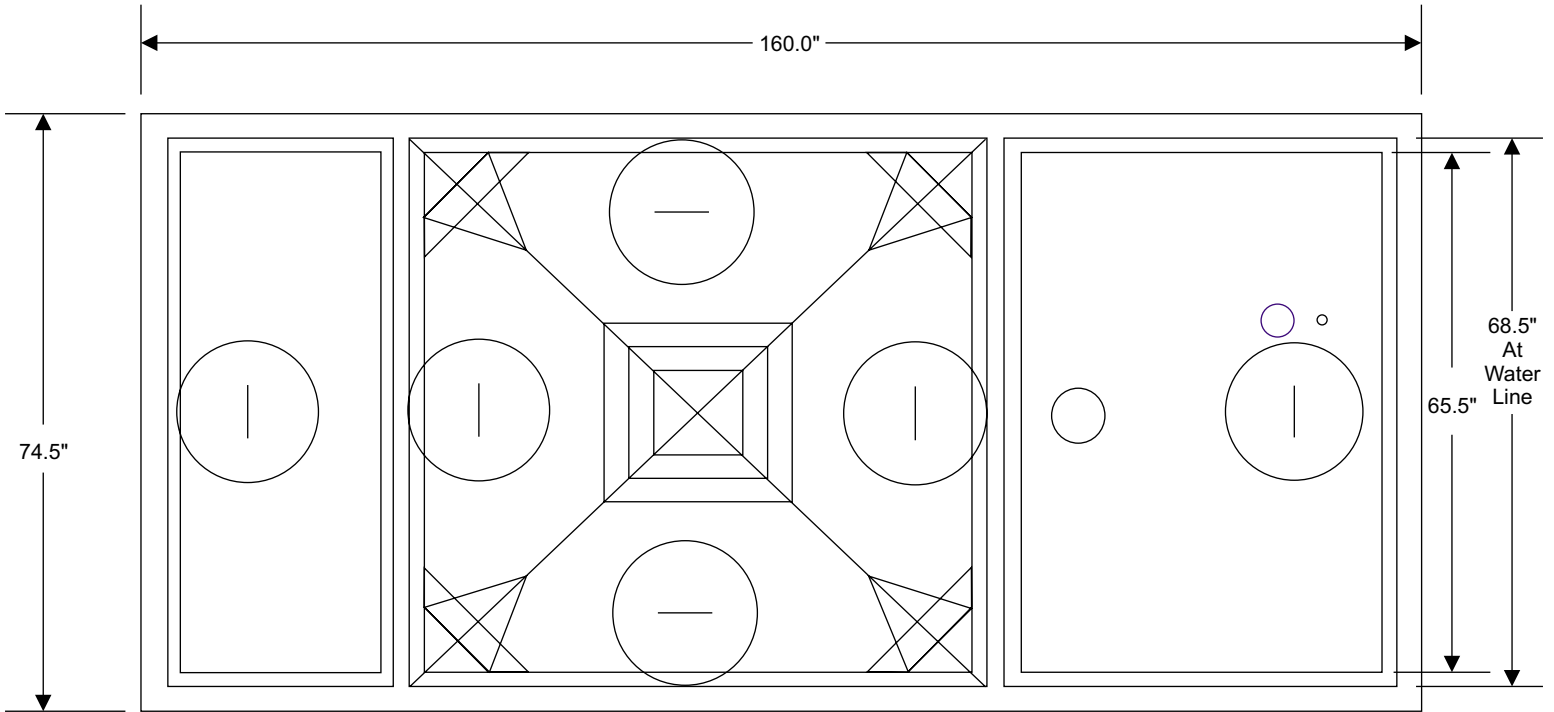

2.229' Avg. Length
5.600' Avg. Width
4.333' Depth

4.187' Avg. Length
5.600' Avg. Width
4.333' Depth

760 Gallons
220 Gallons Remaining In Tank

540 Gallons Holding Capacity