

# Colorado Hoot™ 4 Bedroom Siphon

FLXX™

FLXX™

Note: N.T.S

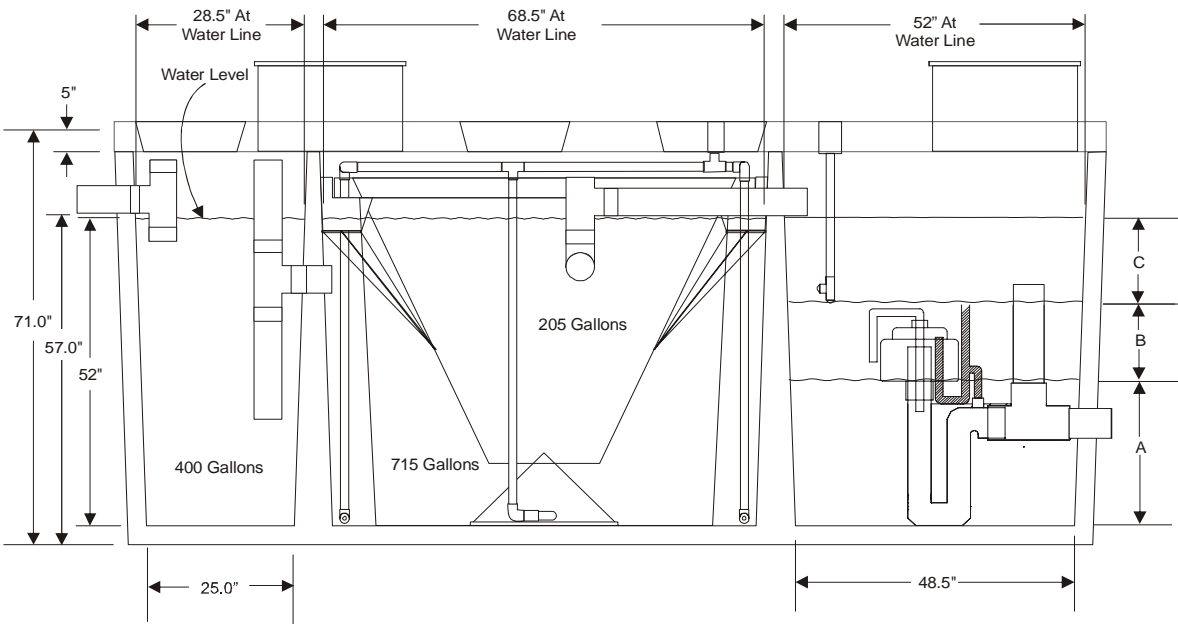
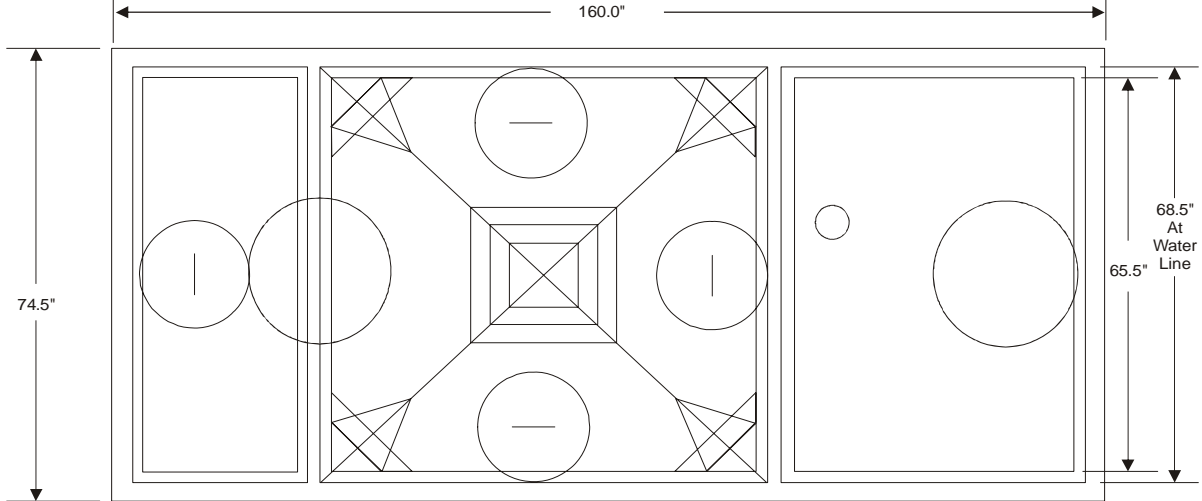

**Siphon 308**  
 A = 19" = 277 Gallons  
 B = 8" = 177 Gallons  
 C = 25" = 366 Gallons

**Siphon 313**  
 A = 19" = 277 Gallons  
 B = 13" = 190 Gallons  
 C = 20" = 293 Gallons

**Siphon 316**  
 A = 22" = 321 Gallons  
 B = 16" = 234 Gallons  
 C = 14" = 205 Gallons



**Front Range Precast Concrete, Inc.**

5439 N. Foothills Highway

Boulder, Colorado 80302

Ph: (303) 442-3207, (800) 783-3207 — Fax: (303) 442-3209

www.fronrangeprecast.com